

aP58QWC16S-V3B Writer User Manual

Aplus Integrated Circuits, Inc.

www.aplusinc.com.tw

sales@plusinc.com.tw

Introduction

The aP58QWC16S-V3B Writer is designed to support aP58Q6-SOP16 IC and DBQ6-S16 module.

This development system serves main functions:

Compiler – to create rom file and flash file

Writer – to download the rom file and flash file into the aP58QWC16S-V3B Writer

The **Compiler** is used to combine the edited voice files into the chip to form the desired Voice Group and to define the playback functions of each Voice Group by selecting different Options and Trigger Modes of each individual Voice Group.

The **Writer** is used to download the file into the aP58Q6 devices that resulted from the Compiler Function. A Writer Board connected to the PC via USB port is required.

Hardware Installation

aP58QWC16S-V3B writer is a USB based writer programmer. It is intended to be used in Win7,Win8,Win10, Win11 computer.

aP58QWC16S-V3B writer does not need to be installed, just double click aP58Q_Software.exe to start it.

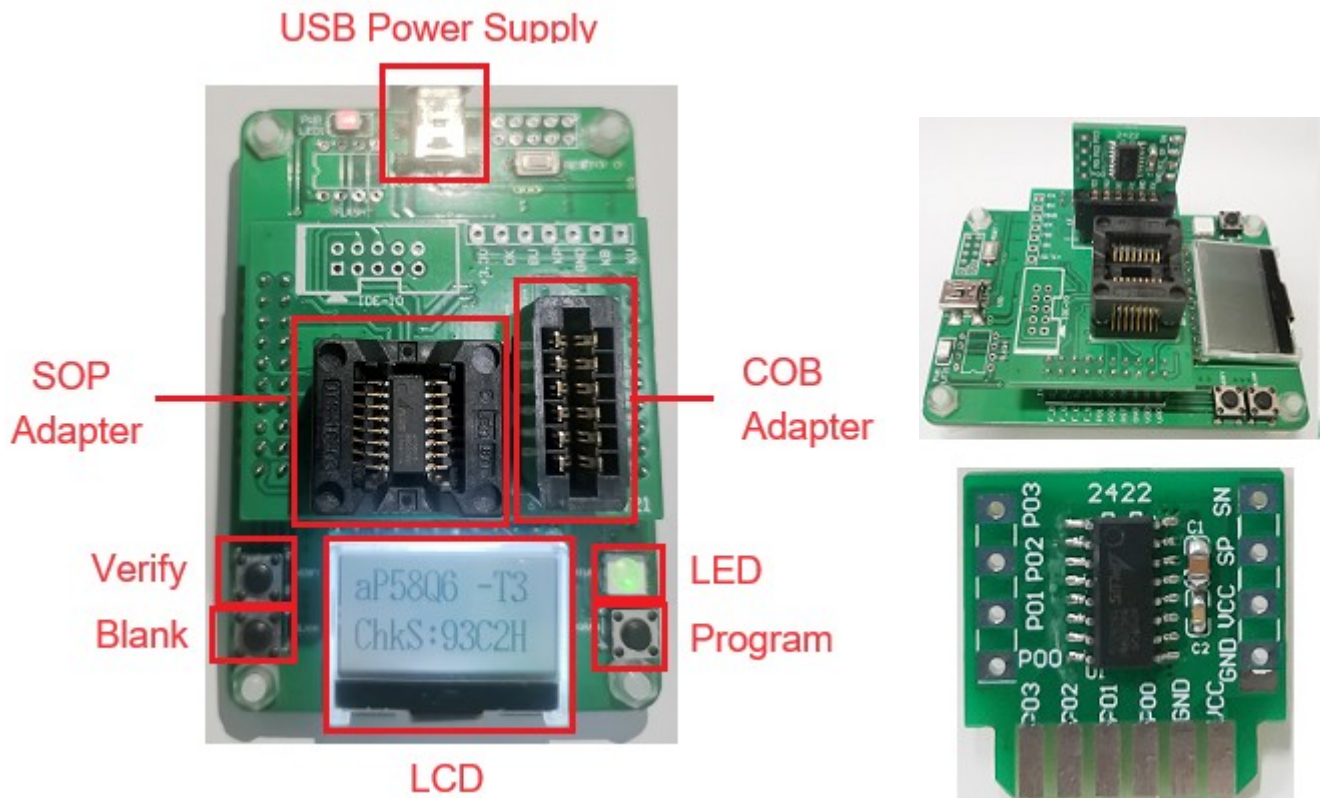

aP58QWC16S-V3B

DBQ6-S16 (Ver.3)

Operate :

Power supply: The writer uses 5V power supply from the USB interface, and the red light turns on when powered on.

First Download the ROM File and Flash File to the Buffer of aP58QWC16S-V3B writer.

BLANK Button: Press the blank key, the blue light is on, indicating that the blank is being checked
The red light is on, indicating that the empty search has failed;
The green light is on, indicating that the blank check has passed.

PROGRAM Button: Press the programming key, the blue light is on, indicating that programming is in Progress.
The red light is on, indicating that the programming failed.
The green light is on, indicating that the programming is successful.

VERIFY Button: Press the verify key , the blue light is on, indicating that the verification is in progress
The red light is on, indicating that the verification failed;
The green light is on, indicating that the verification is successful.

Running The Software

Compiler accepts 16 Bit 、 MONO 、 WAV format.

Double click the file **aP58Q_Software.exe** to launch the software.

COMPILER :

The screenshot shows the 'aP58Q Software ver 1.27' compiler window. It features a menu bar (Compiler, Writer, About), a toolbar with icons for file operations and execution, and several data tables. Callouts 1-14 highlight specific UI elements: 1 (Title bar), 2 (File icons), 3 (Project name), 4 (Mode dropdowns), 5 (Compiler menu), 6 (IO Pins table), 7 (File list table), 8 (Group table), 9 (Empty workspace), 10 (Step table), 11 (Step details), 12 (Checksum), 13 (ROM Space), and 14 (Flash Space).

IO Pins	I/O	Function	Sequence	On/Off	Trig Level	Hold	Trigger	Pull High	Init Out
P00	input	TG	Sequential		level	unholdable	retrigger	7K/900K	
P01	input	VOL++			edge	unholdable	retrigger	7K/900K	
P02	input	VOL--			edge	unholdable	retrigger	7K/900K	
P03	output	BusyH							low

Section Name	Size	Smpl Rate	Play Rate	Codec	Volume	Space	Location
001.wav	68,085	16,000	15,625	AD5	100%	1.6 %	Flash
002.wav	67,430	16,000	15,625	AD5	100%	1.6 %	Flash

Group	Loop
Group 1	P00.Group1 (1)
Group 2	P00.Group2 (1)

Step	Codec	Location	P03
002.wav	AD5	Flash	BusyH

Bottom status bar: ChkSum : F056 | ROM Space | 12 % | Flash Space | 135,605 / 4,194,304 Bytes

COMPILER DESCRIPTION:

1. New Project : Generate new page.
 Open Project : Open old file. (*.dp5q)
 Save : Save current project to hard disk.
 Save Project as : Save as new file.
 Build : Click Build to output .rom .flash . dp5q and .html , 4 files and save to the folder.

Setup Options :

The screenshot shows the 'Setup Options' dialog box for 'aP58Q Software ver 2.07'. It contains several configuration panels: 'Audio Amplifier' (PWM), 'PWM Volume' (High), 'Volume Control' (Enable Volume Control checked), 'Power On' (PowerOn Play, PowerOn Beep, Error Beeps), 'Low Voltage Reset' (Off), 'Key Trigger' (Debounce Time: 0 ms, Trigger Level: Low Trigger), 'Sleep' (LDO_3V, Off), and 'MCU Modes' (Command Width: 8 bits). Callouts a-g point to these respective sections.

a. Select Audio Amplifier.
--- DAC or PWM

b. Select PWM voice output volume.
--- Low / Middle / High

c. Set Volume : There are three options of 16/8/4 level volume control setting available.

Enable Volume Control :

In 1-Wire , 2-Wire , 3-Wire mode, enable / disable volume control.
In SBT , Matrix TG mode, selectt V++ or V-- to enable volume control.

Warp : Enable Wrap, if continue to press VOL++, volume will reach to maximum , then return to the minimum volume. Same for VOL- -

ex Continue press VOL++ : Volume level 4 → 1 → 2 → 3 → 4,
VOL- - : Volume level 4 → 3 → 2 → 1 → 4.

d. Power On Play : Play immediately after power on
Power On Beep : There will be a beep sound when the power is turned on.
Error Beeps : When the power is turned on, if there is an abnormality in reading the flash a long beep and short beep sound will be emitted.

e. Select if using Low Voltage Reset.
--- There are 1.75v / 2.35v / off three options

f. Select required Debounce time.
--- 0ms ~ 170ms.

Select Trigger Level

--- Low Trigger or High Trigger can choose.

g. 8bit can get 223 group max.
16bit can get 4095 group max.

2. One key one sound : Directly configure one Group and one audio source

One key play sequentially : Place all sound sources in the same Group

Collect all resource files : When you can press this item, all relevant documents will be collected.

3. Select your required IC body.

--- aP58Q6 / aP58Q7M / aP58Q8M

4. Select your required trigger mode.

--- SBT Mode / KEY(Matrix) Mode / 1-Wire Mode / 2-Wire Mode / 3-Wire Mode.

5. Select I/O function

--- The different i/o pin function will generate different function options according to your trigger mode.

Setting ON/OFF enable/disable. (The function is only available in SBT MODE)



Output : BusyH , BusyL , 3Hz , 6Hz , LED-dyna , StopH , StopL

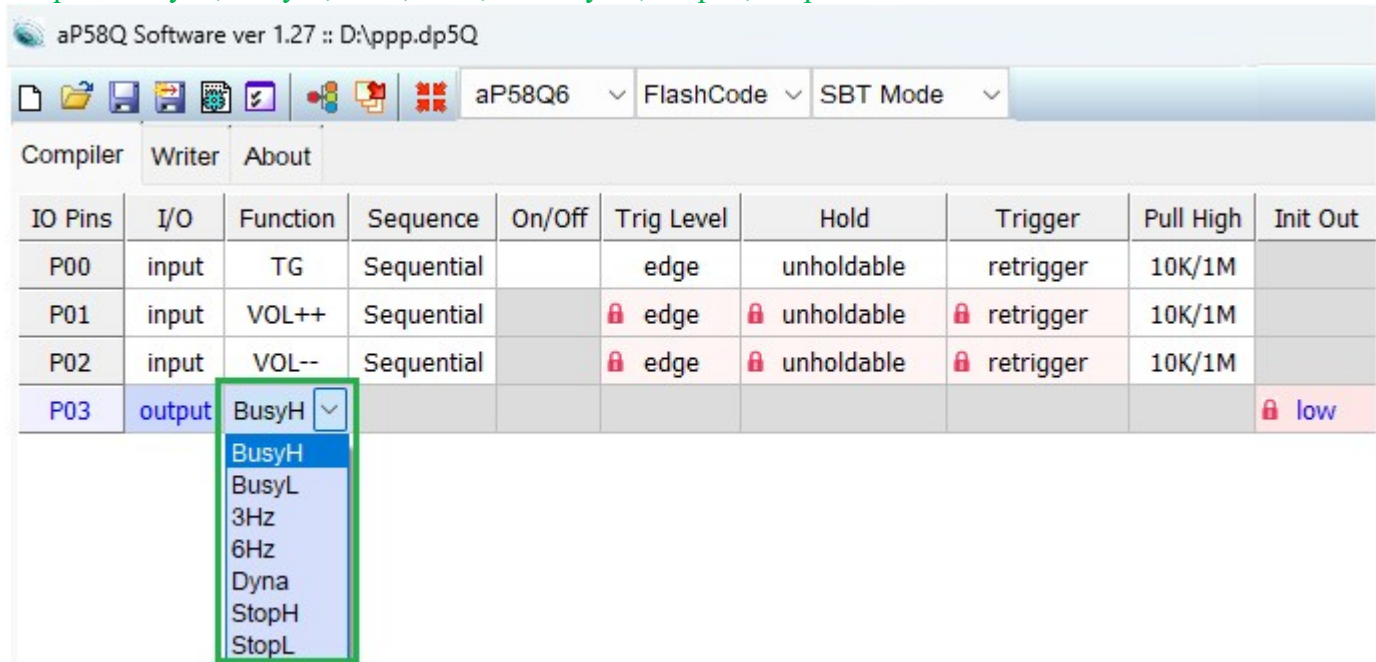

6.



(6a) Enable Sort mode button : Turn on the sorting function of Section listing

(6b) Add Voice : Add Voice Section

- (6c) Add Mute : Add Mute Section
- (6d) Delete : Delete the selected Section (press shift or ctrl to select)
- (6e) Clear All : Clear all Sections
- (6f) Replace Voice : Replace the selected portion of the waveform file (blue word)
- (6g) Play : Play the selected Section (press shift or ctrl to select)
- (6h) Stop : Stop play
- (6i) Move Up : Move the selected Voice Section up one position
- (6j) Move Down : Move the selected Voice Section down one position
- (6k) AD5 : Use AD5 compression for the selected Voice Section
- (6l) AD6 : Use AD6 compression for the selected Voice Section
- (6m) AD8 : Use AD8 compression for the selected Voice Section
- (6n) PCM10 : Use PCM10 compression for the selected Voice Section
- (6o) PCM12 : Use PCM12 compression for the selected Voice Section

7. Loading the required *.wav files

Different compression methods can be selected for each sound source

--- AD5 / AD6 / AD8 / PCM10 / PCM16.

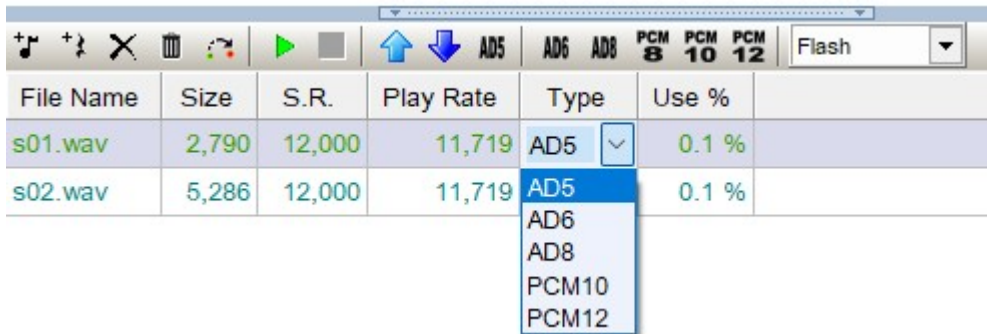

File Name	Size	S.R.	Play Rate	Type	Use %
s01.wav	2,790	12,000	11,719	AD5	0.1 %
s02.wav	5,286	12,000	11,719	AD5	0.1 %

The screenshot shows a software interface with a toolbar at the top containing icons for adding, deleting, playing, and stopping, along with buttons for compression methods: AD5, AD6, AD8, PCM 8, PCM 10, PCM 12, and Flash. Below the toolbar is a table with columns for File Name, Size, S.R., Play Rate, Type, and Use %. Two rows of data are shown, both with 'AD5' selected in the Type column. A dropdown menu is open for the 'AD5' entry in the second row, showing options: AD5, AD6, AD8, PCM10, and PCM12.

8.



- (8a) Add Group : Add a Group at the end of the Group List
- (8b) Insert Group : Insert a new Group at the selected Group position
- (8c) Delete Group : Delete the selected Group (press shift or ctrl to select)
- (8d) Clear All Group : Clear all Groups in the current TG
- (8e) Play Group : Play selected Group
- (8f) Stop : Stop play

9. Setting your required voice sections.

10.



- (10a) Add Step : Add a new Step at the end of Step List
- (10b) Insert Step : Insert a new Step at the selected Step position
- (10c) Delete Step : Delete the selected Step (press shift or ctrl to select)
- (10d) Clear All Step : Clear all Steps in the current Group
- (10e) Play Step : Play the selected Step (press shift or ctrl to select)
- (10f) Stop : Stop play
- (10g) Move Up : Move the selected Step up one position (press shift or ctrl to select multiple items)
- (10h) Move Down : Move the selected Step down one position (press shift or ctrl to select multiple items)

11. Show the voice content placed by GROUP. Operation method first go to the upper right box and click Group, then go to the lower left box and click the required voice, and then enter the lower right box to indicate success.

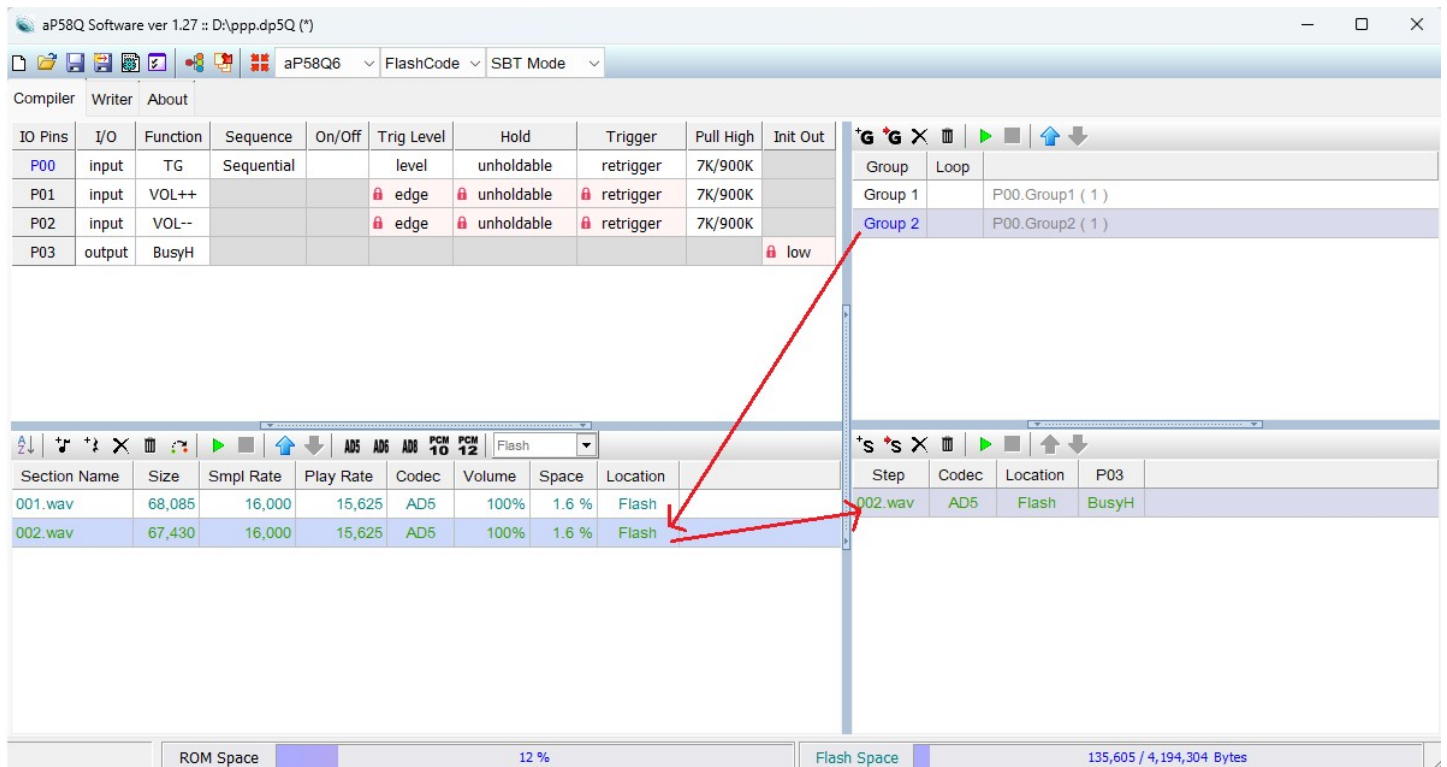

12. The check sum value of the burning file for copier use.

13. Rom Space : Show Function(OTP) rom memory usage.

14. Flash Space : Show Voice Data flash memory usage.

When you complete the settings, click **Build** and save file name. It will create **.rom .flash .dp5q .htm** , 4 files.

.rom are re-programmable. But should be under same AP58Q software version. If rom is compiled by different AP58Q software version, it will re-program fail.

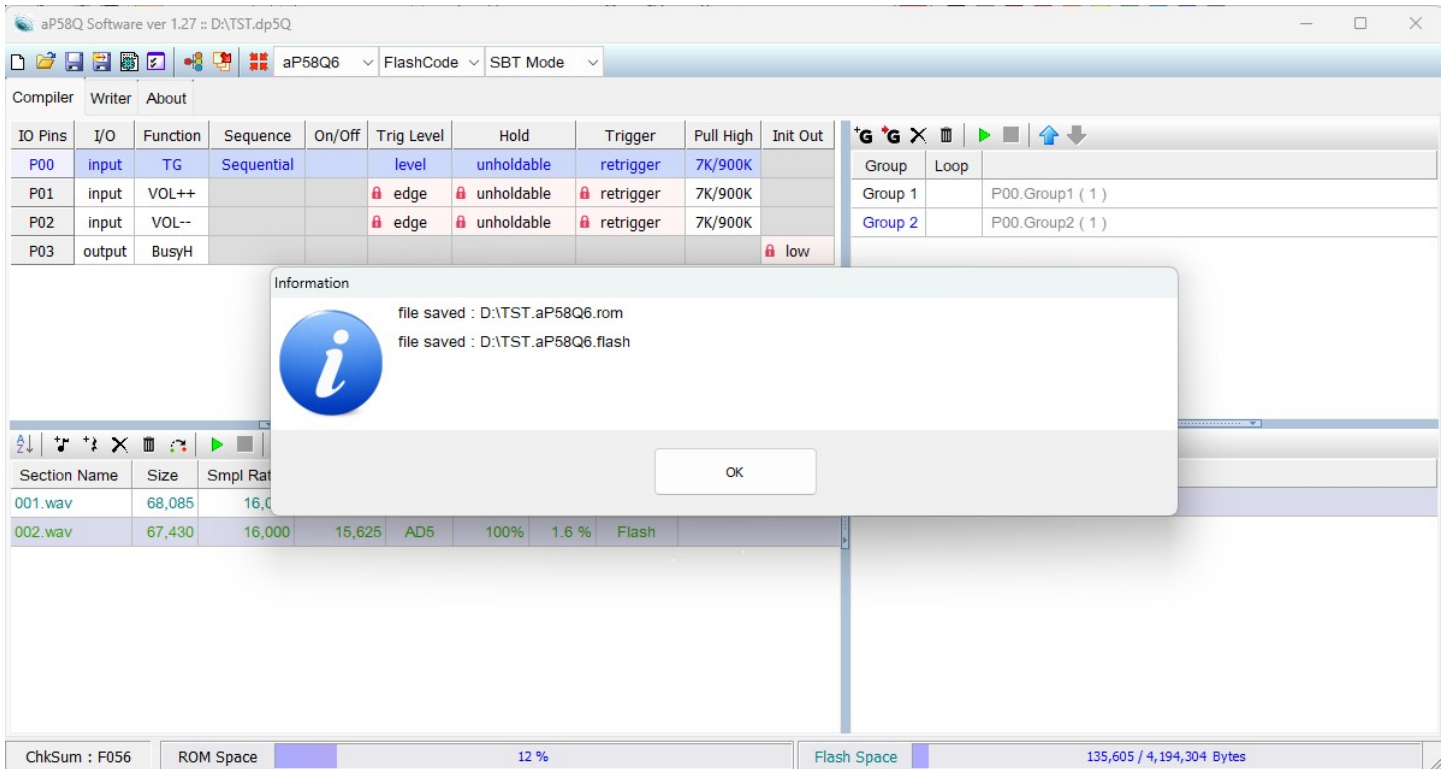
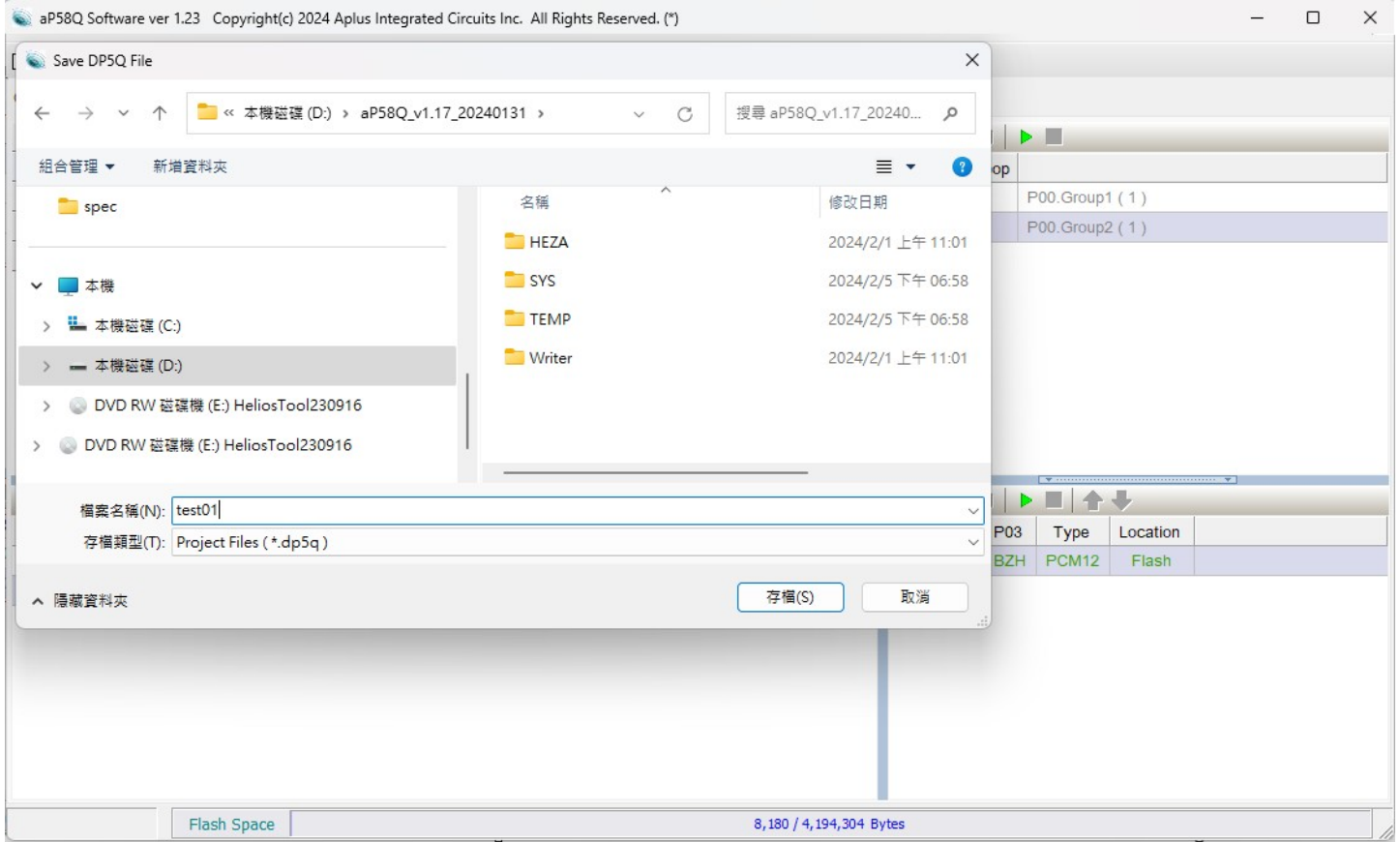

IMPORTANT Note :

P03 supports TG , V++ , V-- , RST and Output. But Reset is OTP option. When P03 set in Reset, re-compile other function can not be effective. P03 will still keep Reset.

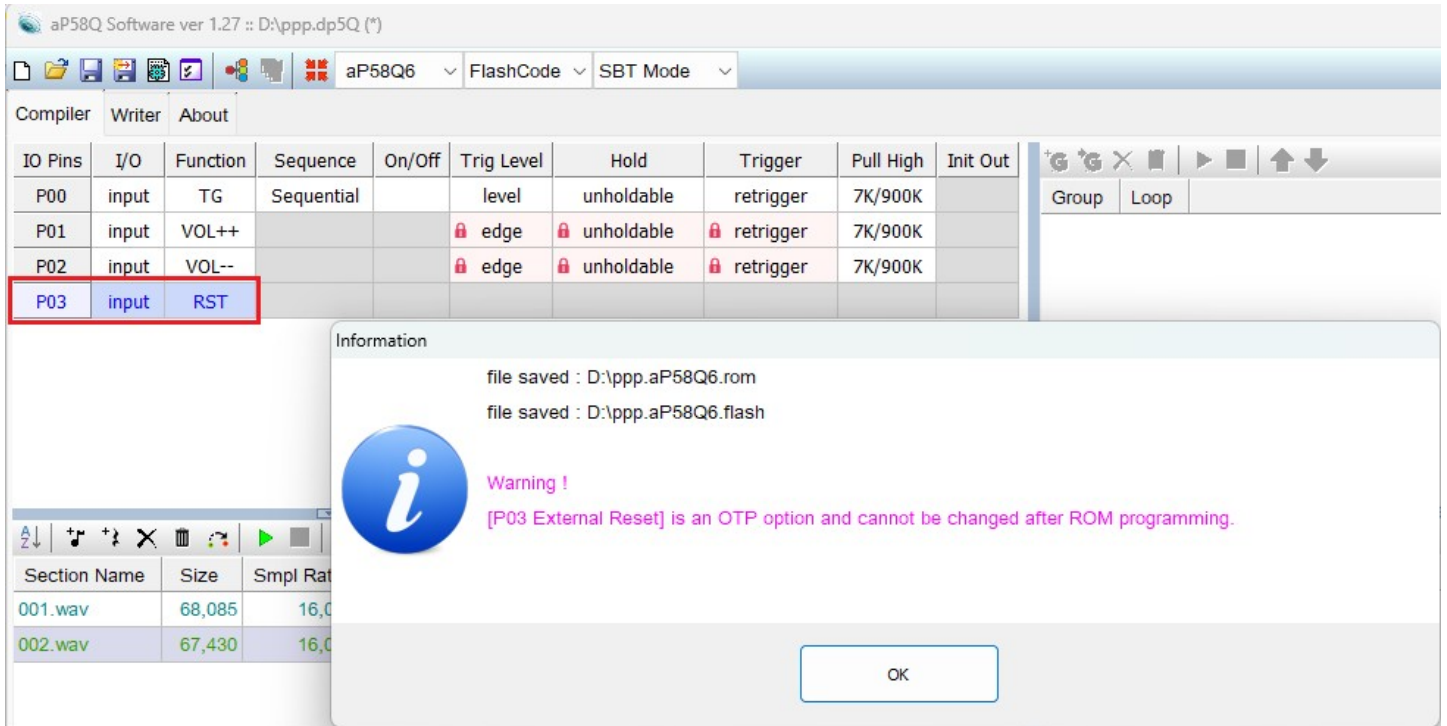

aP58Q6 VOICE DURATION TABLE					
Coding	AD5	AD6	AD8	PCM10	PCM12
SR = 4.6K	23 min.	19.4 min.	14.5 min.	11.6 min.	9.7 min.
SR = 5.8K	18.6 min.	15.5 min.	11.6 min.	9.3 min.	7.7 min.
SR = 6.6K	16.3 min.	13.5 min.	10.1 min.	8.1 min.	6.7 min.
SR = 7.8K	13.9 min.	11.6 min.	8.7 min.	6.9 min.	5.8 min.
SR = 9.3K	11.6 min.	9.7 min.	7.2 min.	5.8 min.	4.8 min.
SR = 11.7K	9.3 min.	7.7 min.	5.8 min.	4.6 min.	3.8 min.
SR = 15.6K	6.9 min.	5.8 min.	4.3 min.	3.4 min.	2.9 min.
SR = 23.4K	4.6 min.	3.8 min.	2.9 min.	2.3 min.	1.9 min.

In **SBT mode** , **KEY(Matrix) mode** , some function selections can be made for a single segment of TG. The function selection is one of two, there are Edge/Level , Holdable/Unholdable , Retrigger/Non-retrigger. The following will be done for the function explain

Edge and Level Trigger :

For both Edge and Level trigger, the chip starts to play when the trigger button is pressed. For Level Trigger, if the trigger key is pressed and keep holding at the pressed position, the chip will continue to play the same sound again and again until the trigger key is released.

However, if the chip is programmed to Edge Trigger, the chip will play the sound only for one time even the trigger key is kept pressing.

Holdable and Unholdable Trigger :

For Holdable Trigger, the chip will play only when the trigger key is kept pressing. Sound playback will stop immediately once the key press is released.

For Unholdable Trigger, the sound section will be played to finished once the trigger is pressed no matter the trigger key is kept pressing or released.

Retrigger and Non-retrigger :

For retrigger option, the currently playing sound will be stopped and new sound section will be played when another trigger key is pressed.

For non-retrigger option, new trigger action will not be granted until the current sound section is finished playing.

▪ **WRITER :**

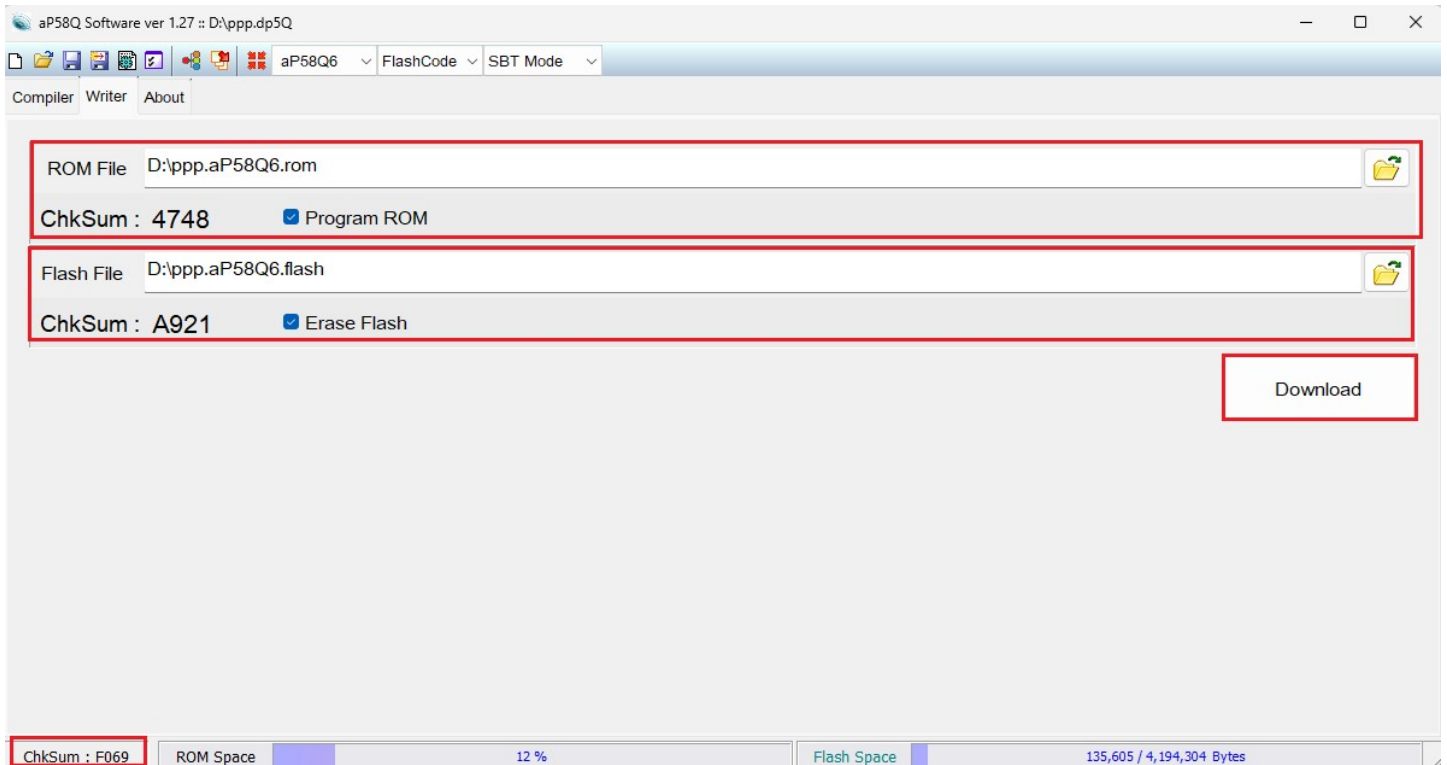

WRITER DESCRIPTION:

1. Loading rom file. (xxx.rom) : Function data file with checksum (ex 5903)
2. Loading flash file. (xxx.flash) : Voice data file with checksum (ex E204)
3. Download the File to the Buffer of aP58QWC16S-V3B.
4. This is for COPIER using only.

Note : Depending on voice duration, program time will be different. Below table is for full voice memory program time

IC part no	Loading time	Access time	Program time
aP58Q6	1min. & 51sec.	6sec	1min. & 14sec

1st program, need to check the box of Program ROM

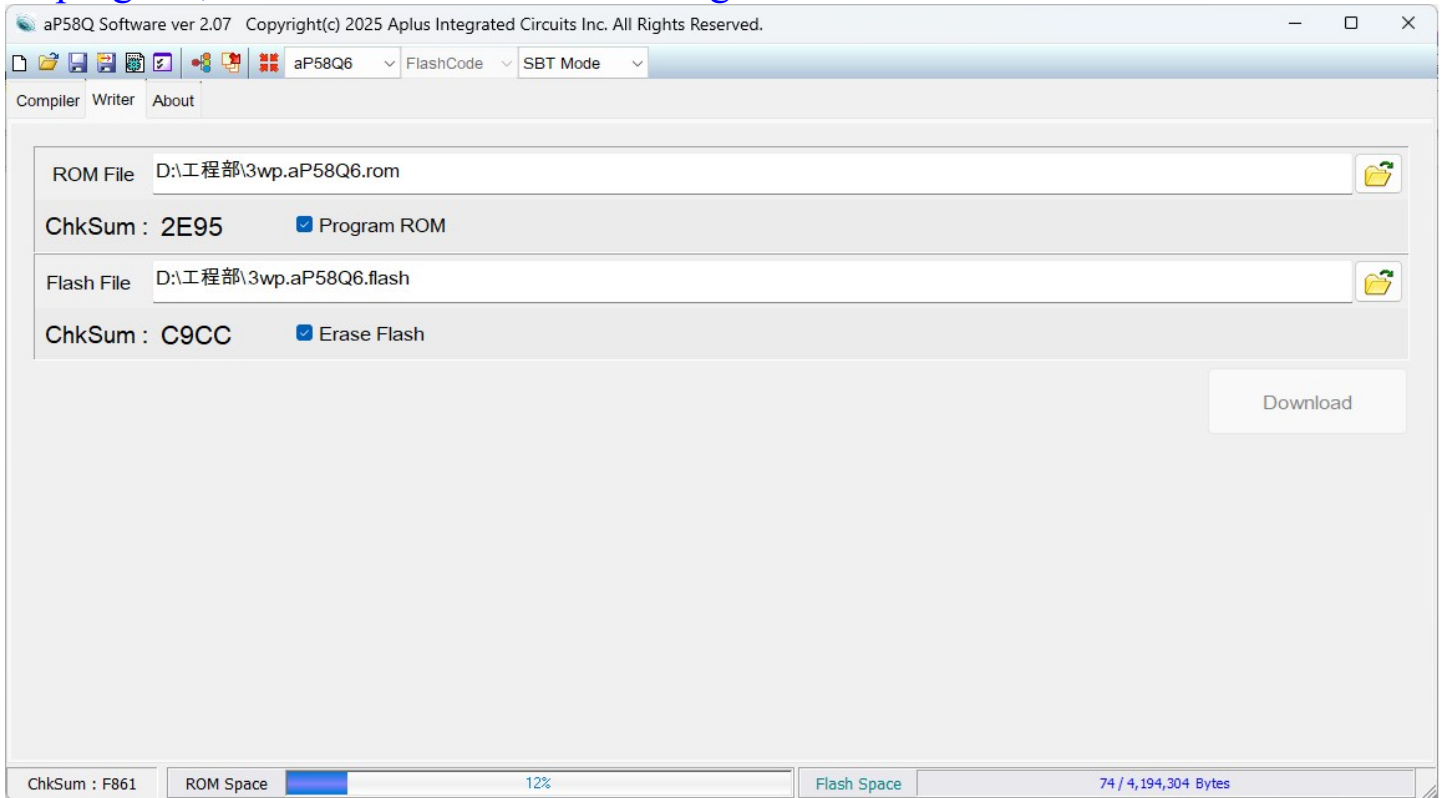

Re-program, DO NOT check the box of Program ROM

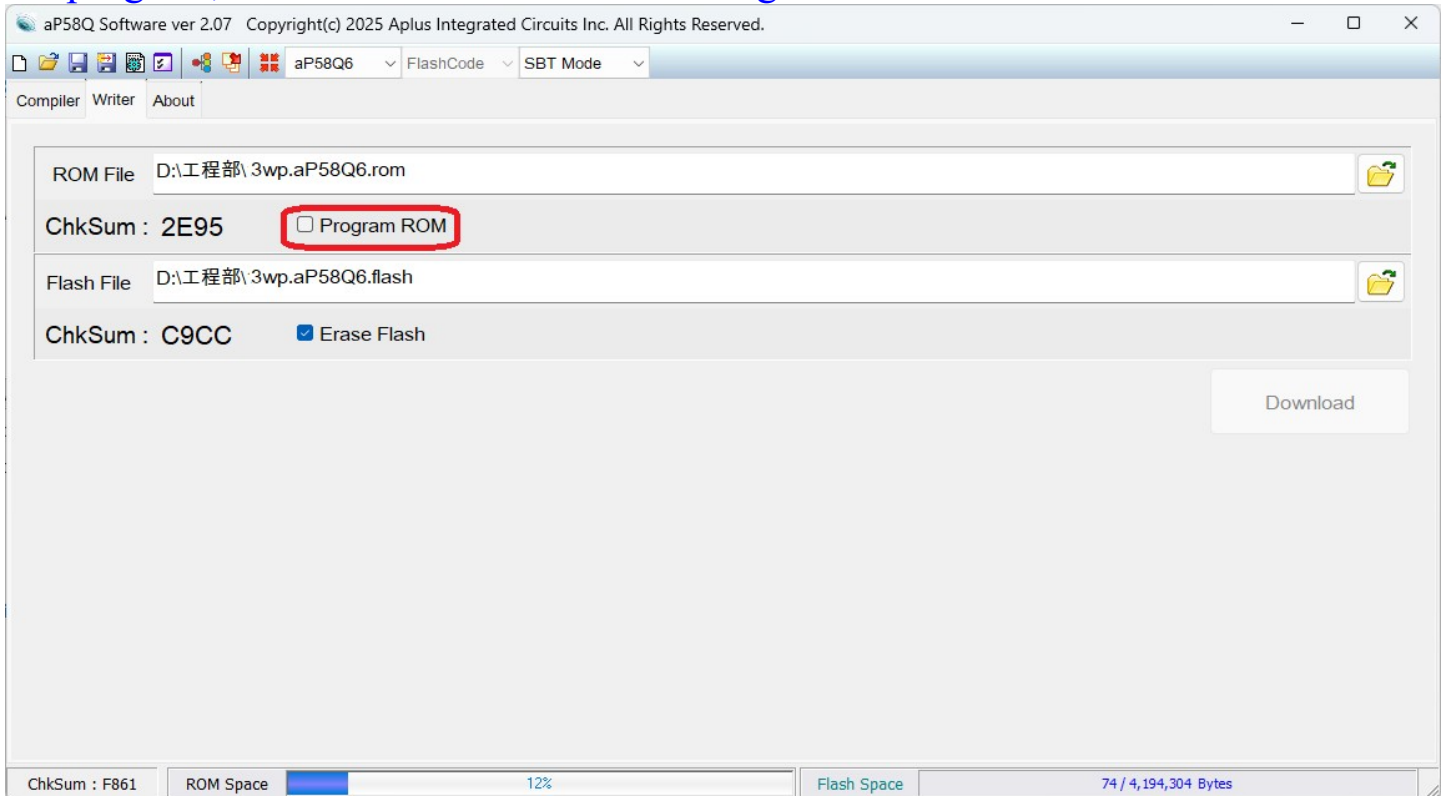

■ **About :**

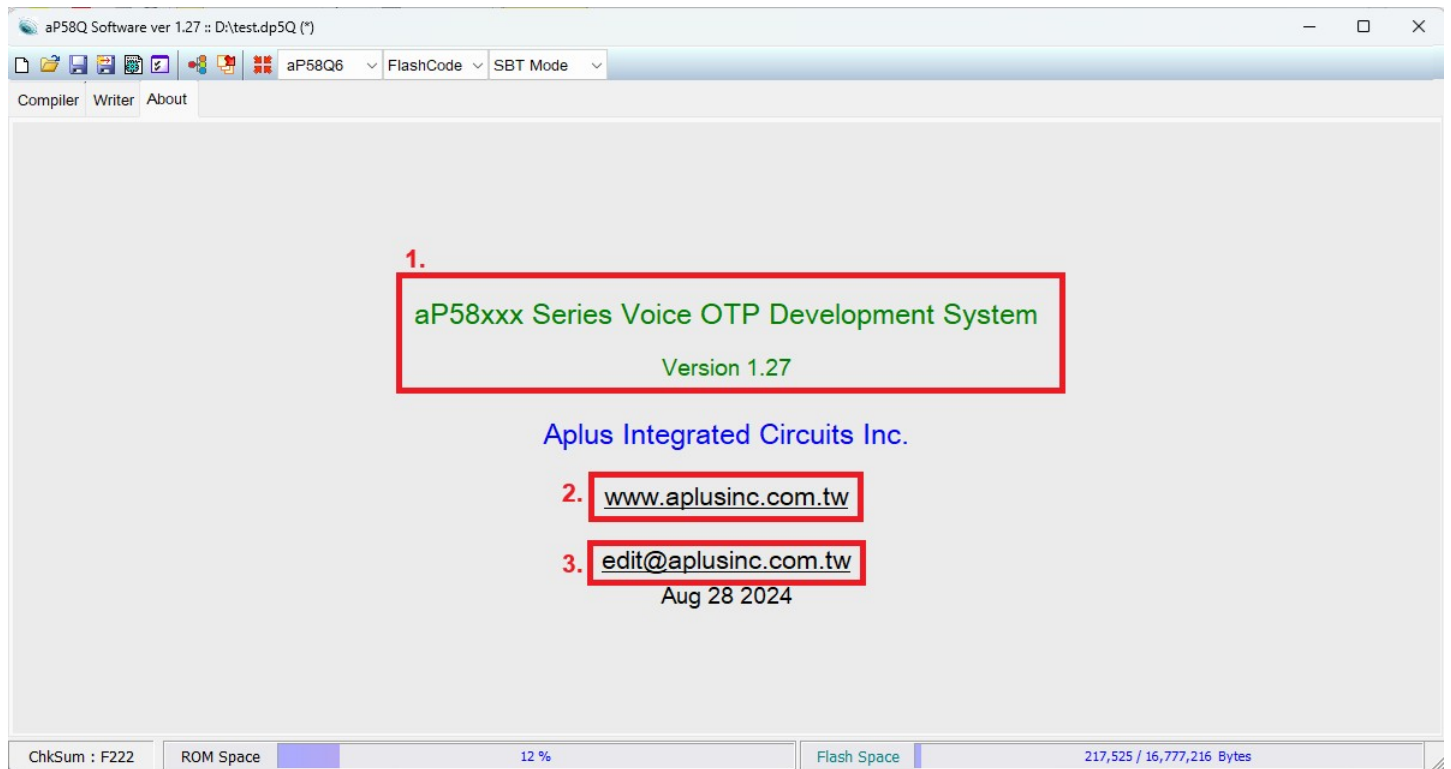

ABOUT DESCRIPTION:

1. Show software version.
2. Show website of Aplus Integrated Circuits Inc.
3. Contact for technical issues.

HISTORY

14 FEB 2024

aP58QWC-V3B Writer User Manual.

06 May 2025

Modify page.4 add g item.

25 May 2026

Page.13 add Explanation of writer operation
